

PARTS DIAGRAM

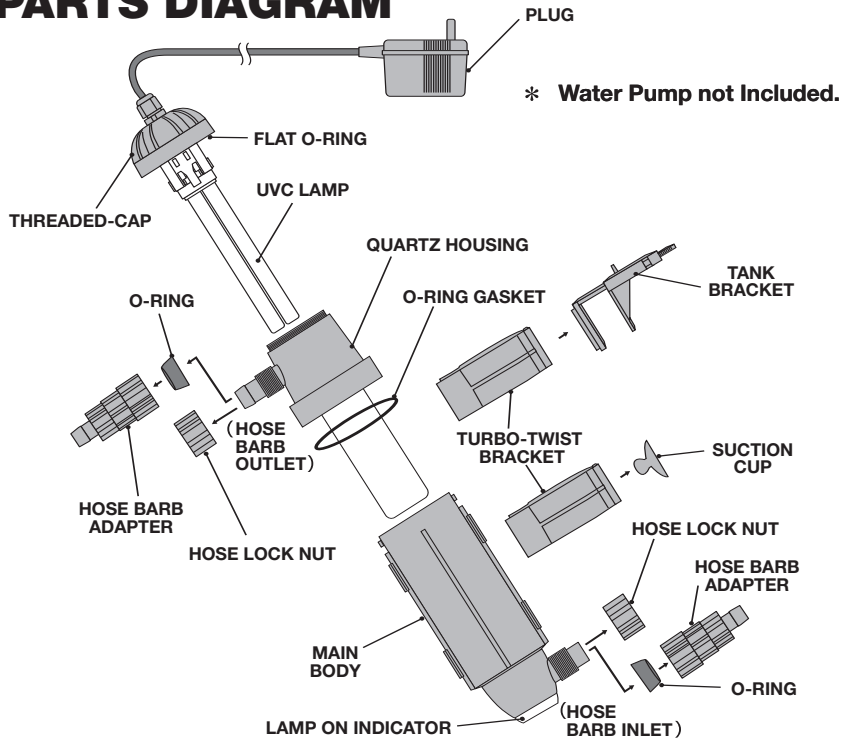

SPECIFICATIONS

Article	Turbo-Twist 3x UV Sterilizer
UV Lamp	9 watt
Rated Voltage	AC120V
Rated Cycle	60Hz
Rated Power	10.2 watt
Irradiation of UV Radiation	9,580 $\mu\text{W}/\text{cm}^2$ (value @ 20mm distance from the UV lamp)
Wavelength of UV Radiation	253.7nm
Life of UV Lamp	Approx. 8000 hours
Aquarium Volume	Treats up to 125 gallon saltwater or freshwater aquariums
Flow Rate	100-200 gallons per hour
Size of O-ring	Inner 12/outer 16mm, inner 16/outer 22mm
Cord Length	Approx. 9 ft.

INSTRUCTIONS

Always disconnect the unit from the power supply before installing the Turbo-Twist.

The Turbo-Twist provides superior aquarium health and appearance by eliminating most harmful microorganisms.

1 Set-up and positioning

● Adjusting the hose barb inlet and outlet.

The hose barbs can be positioned in four different locations to facilitate connections to other applications.

- ① Lift the red safelock and unlock the quartz housing. (Picture 1)
- ② Carefully twist the quartz housing and the main body opposite of each other. (Picture 2)
- ③ The quartz housing can now be rotated 360°. (Picture 3)
Adjust the orientation of the hose barb and set the main body into the quartz housing.
- ④ Combine the main body with the quartz housing and rotate according to the arrowhead "close". (Picture 4)
- ⑤ Press in the red safelock and the UV Sterilizer is now ready to install. (Picture 5)

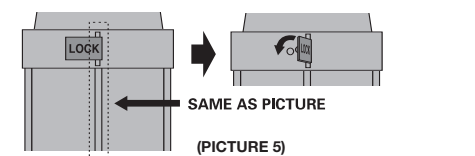
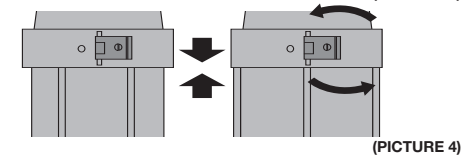
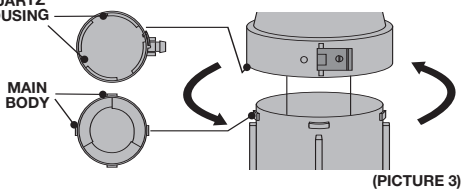
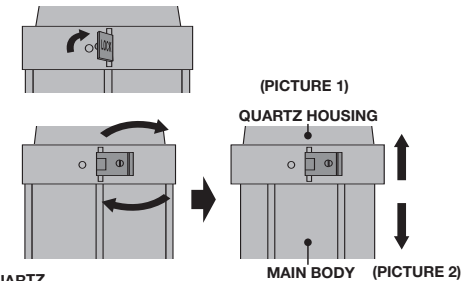
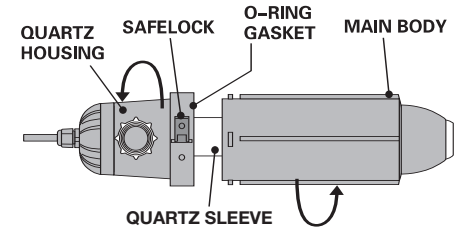

● Bracket Installation

- ① Adjust the tank bracket so that it hangs on the outside of the aquarium.
- ② Slide the Turbo-Twist bracket onto the tank bracket. Make sure the Turbo-Twist bracket is securely fastened onto the tank bracket.

RANGE OF THE CLAMP

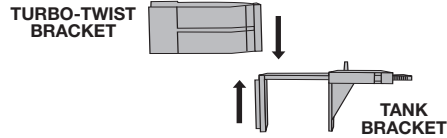
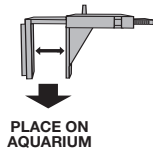
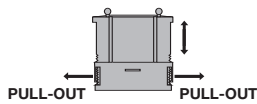

- ③ Once step 2 is finished, snap the main body into the bracket indicated by a "click". Snap the other bracket with the suction cup in the same way.

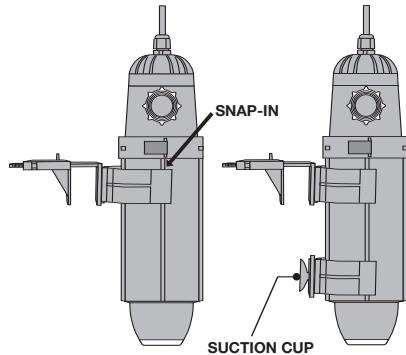
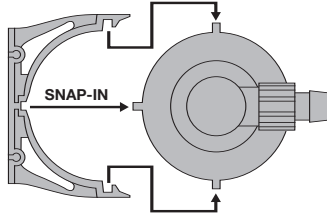

- ④ For horizontal positioning, take the suction cup out and snap the main body into the brackets until it locks with a "click".

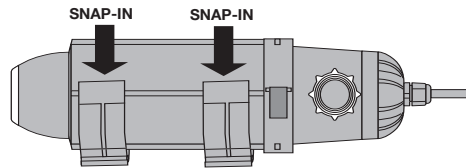

2 UV Lamp installation

Remove threaded-cap, install UV lamp into socket until lamp "clicks" into place.

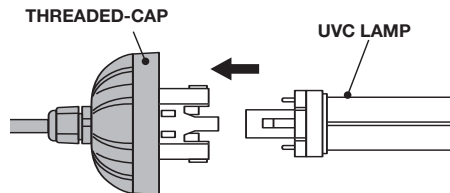

3

Make sure that the flat O-ring gasket is properly positioned inside the threaded-cap (already installed in unit). Screw the threaded-cap tightly back into place.

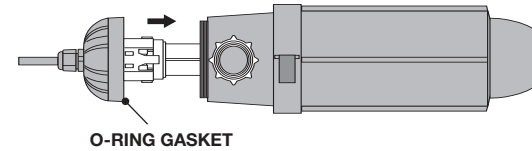

Note: The plug and cord should be turned together when screwing the threaded-cap back into place.

4 Attaching the hose lock nuts

- ① Position the hose lock nuts on the hose-barb inlet/outlet.
- ② Use flexible tubing to connect the sterilizer to the water supply. Turn the hose lock nut counter-clockwise to tighten flexible tubing onto the hose barb. Hose lock nuts require only hand tightening.

HOSE LOCK NUT

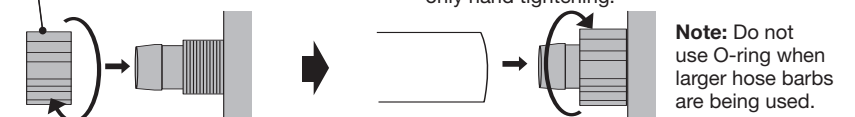

Note: Do not use O-ring when larger hose barbs are being used.

● Hose barb adapter installation

- ① Place the O-ring on hose barb inlet/outlet.
- ② Hand tighten the hose barb adapter onto the Turbo-Twist.
- ③ Use flexible tubing to connect the sterilizer to the water supply. Turn the hose lock nut counter-clockwise to tighten flexible tubing onto the hose barb.

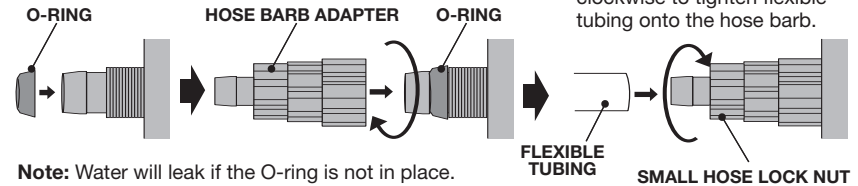

Note: Water will leak if the O-ring is not in place.

5 Installing the Turbo-Twist

- ① Hang the unit using the Turbo-Twist bracket and suction cup on the outside of the aquarium.

Adjust the tank bracket to secure the Turbo-Twist UV Sterilizer.

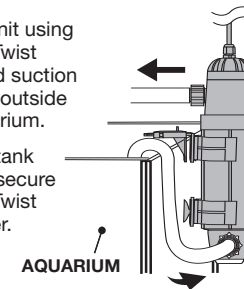

● Horizontal Positioning

- ① Attach Turbo-Twist bracket with screws on a fixed surface.

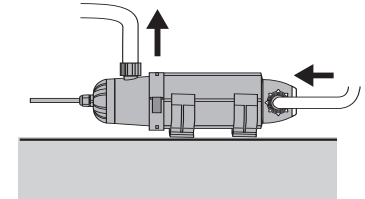

6 Water flow outlet connection

- 1 Connect the tubing between the water flow outlet and the hose barb inlet.

It is recommended that a prefilter be used with the Turbo-Twist to limit the amount of debris entering the sterilizer.

Warning: Never install a valve directly on the tubing between the main body and the aquarium.

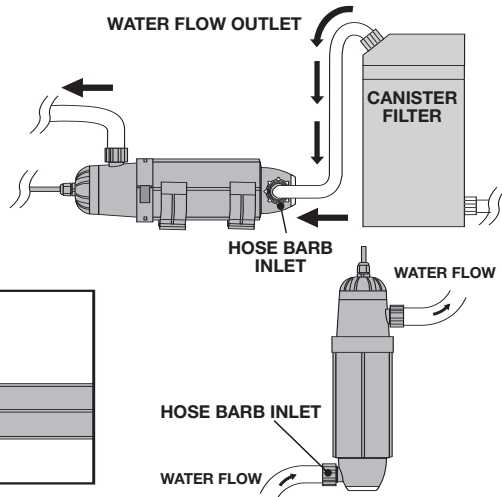
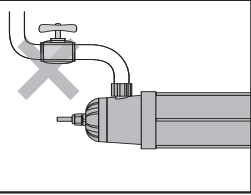

Note: Make sure that the tubing is not carrying the weight of the Turbo-Twist UV Sterilizer. Use the Turbo-Twist brackets to support the unit.

- 7 Turn on water supply to the Turbo-Twist. Once proper water flow has been established, tilt the unit and let the air bubbles inside the tubing and the main body escape. Examine the unit and check for any leaks.

- 8 Connect the Turbo-Twist to the power supply. Verify that the UV lamp is working properly indicated by the light blue glow emitted through the lamp on indicator. The light from the lamp on indicator will not affect the skin or the eye.

Note: When the Turbo-Twist is turned on, you may see patterns on the body of the unit. This does not affect the quality of the unit.

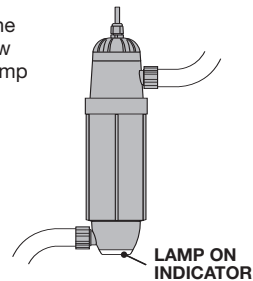

CAUTION

- Never look directly at the unshielded lamp as the ultraviolet radiation is harmful.
- Disconnect the unit from the power supply when installing or repairing the UV sterilizer.
- Never submerge the unit in water.

MAINTENANCE

To ensure superior kill-rates of the sterilizer, the quartz sleeve should be cleaned periodically.

1 Cleaning the quartz sleeve

- 1 Be sure to disconnect power outlet and turn off the pump and let the water drain out of the Turbo-Twist UV sterilizer before cleaning.

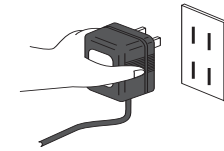

- 2 Lift the red safelock and unlock the quartz housing. (Picture 1)

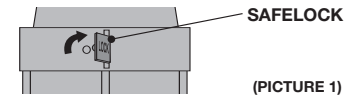

- 3 Carefully twist the quartz housing and the main body opposite of each other. (Picture 2)

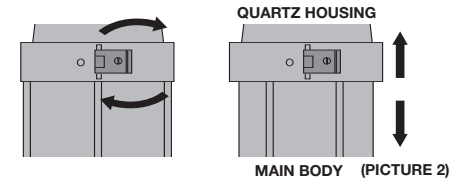

- 4 Slide the quartz sleeve out of the main body. (Picture 3)

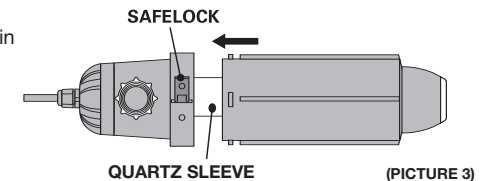

- 5 Wipe the quartz sleeve using a soft, damp cloth. Do not use household cleaners or abrasive scrubbers to clean the quartz housing.

- 6 Once clean, reinstall the quartz sleeve into the main body and push the red safelock into the lock position.

CAUTION

- Never look directly at the unshielded lamp as the ultraviolet radiation is harmful.
- Disconnect the unit from the power supply when installing or repairing the UV sterilizer.
- Never submerge the unit in water.

TROUBLE SHOOTING

UV-C Lamp is not working	● The plug is not connected to the power supply	● Connect the plug to the power supply
	● UV lamp base is loose	● Push the UV-C lamp onto the socket until a "click" is heard
	● The lamp has expired	● Replace the UV-C lamp
Water leak between the main body and hose lock nuts	● The hose lock nut is loose	● Tighten the hose barb or the hose lock nut
	● The O-ring is not in place	● Install the O-ring

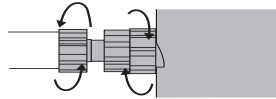

UV-C LAMP REPLACEMENT

The UV-C lamp has a useful life of about 8,000 hours. To ensure effective performance, replace the UV-C lamp before it expires.

1 How to replace the UV-C lamp

- 1 Disconnect the sterilizer from the power supply. (It is also necessary to disconnect the power to the water pump).
- 2 Remove the threaded cap to uncover the lamp socket.
- 3 Unplug the UV-C lamp out of the main body.

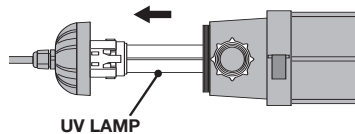
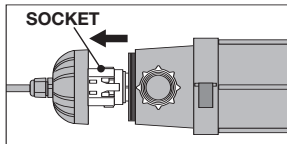

- 4 Pull the UV-C lamp out of the socket (Be careful not to touch the lamp as it may be hot).

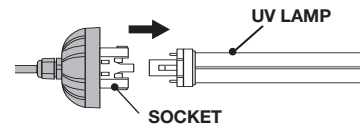

- 5 Make sure that the pins of the lamp plugs into the socket indicated with a "click".

- 6 Reverse steps 5-1 to reassemble the Turbo-Twist.

⚠ WARNING ⚠

Please read the instructions in their entirety before attempting to use this unit.

Cut off the power and stop using if the unit was submersed or dampened by water



Cut off the power immediately if water enters into the Quartz Housing.



Cut off the power if there is a burning or smoking smell.



Never connect the sterilizer to the power outlet while hands are wet.

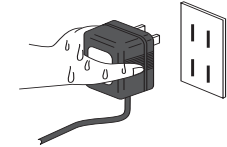

Never look directly at the unshielded lamp as the ultraviolet radiation emitted from the lamp can be harmful.



Do not pull cord to disconnect power.



Always leave a drip-loop in the power cord to prevent water from running down the length of the cord and reaching the power outlet.



Though the Turbo-Twist is water resistant, it should never be intentionally submersed in water. Always install the sterilizer in a location where there is little likelihood of flooding or water dripping directly onto the unit.

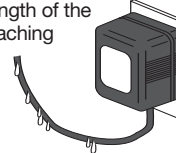

The water temperature flowing through the unit should be below 105°F (40°C).



Make sure that appropriately sized hose lock nuts are positioned on hose barbs before attempting to connect tubing.



Always disconnect the unit from the power supply before shutting down the flow of water to prevent the unit from overheating.



Only a 120V (60 Hz) electrical source should be used with the Turbo-Twist.



SUGGESTED TUBING CONNECTIONS

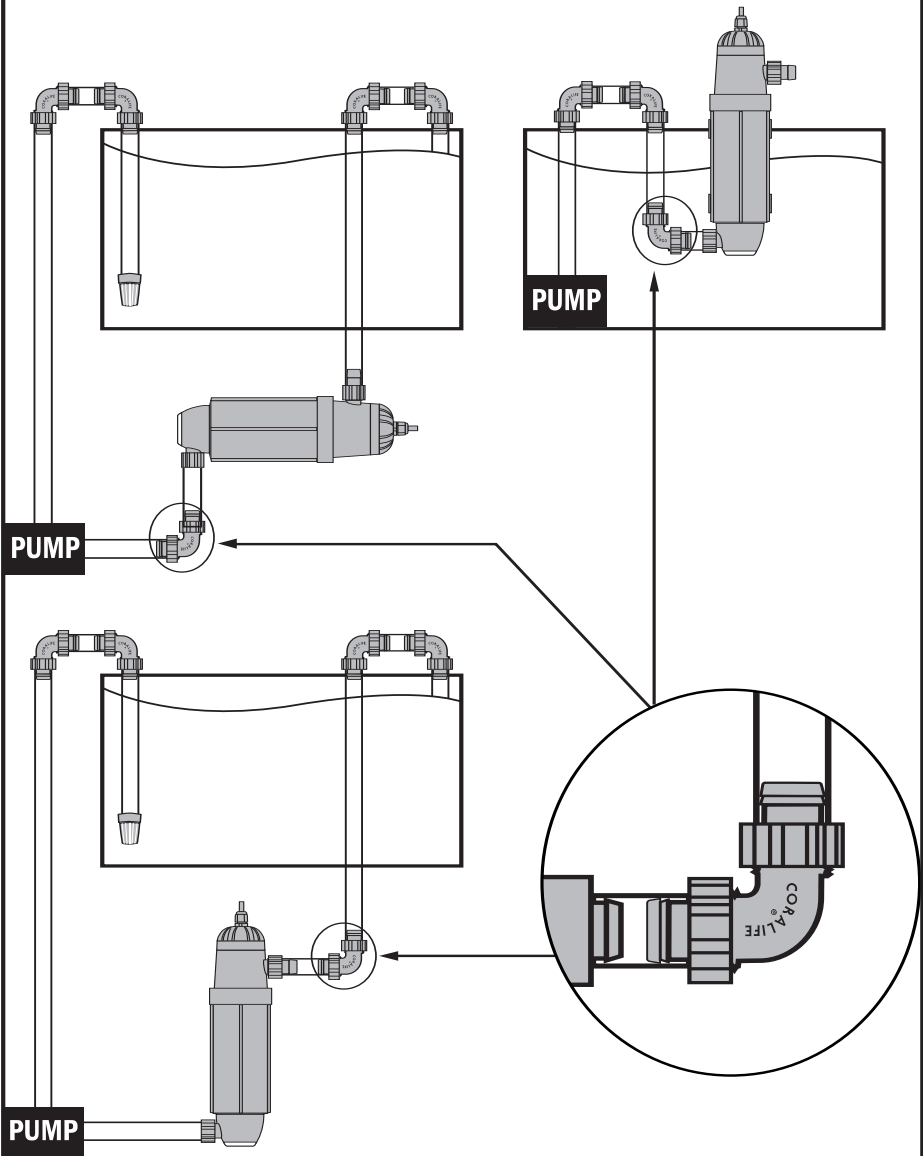

Coralife Turbo-Twist 3x™ -UV Sterilizer

